

MATRIX®
SNUG

ADJUSTABLE HEADREST



The award-winning **Matrix® SNUG Headrest Pad** designed to provide precise fit and easy adjustability. A variety of models are available to meet individual needs and provide unmatched support and comfort.

Call to order

US: 1.888.433.6818 | CAN: 1.866.748.7943
motionconcepts.com



matrix® SNUG

Adjustable Backing Plate

Hinged Aluminum Plate available with symmetrical or asymmetrical lateral support wings.

Foam Backing Pad

Soft, lightweight, and washable EVA foam backing.

Outer Cover

Startex covers are available either fabric or wipeable Infection Control side out. Zippered for easy removal for adjustments or laundering.



Adjustment Hardware

Hinge adjustment hardware is easily accessible through the slit on pad's rear side, without removing covers or padding.

HUG Headrest Pad

Highly conformable HUG headrest pad. Machine wash and dry.

StaminaFibre® Fill

Hypoallergenic, pillow-soft and fully machine washable. Unmatched conformity, comfort and durability.



SNUG HEADREST PAD OPTIONS

Symmetrical

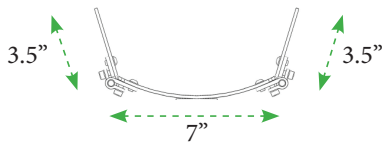

Startex® SNUG14
Infection Control® SNUG14-IC

Asymmetrical

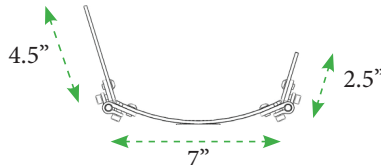

Startex® SNUG14-A
Infection Control® SNUG14-A-IC

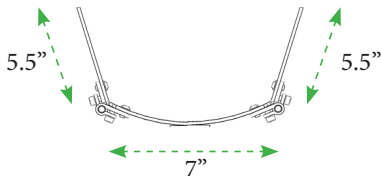

Startex® SNUG-D
Infection Control® SNUG-D-IC

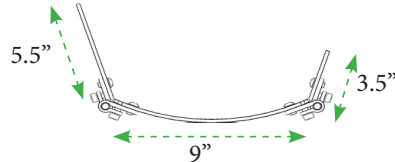

Startex® SNUG18-A
Infection Control® SNUG18-A-IC

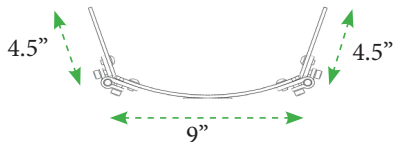

Startex® SNUG18
Infection Control® SNUG18-IC



Headrest Offset mounting plate
SIDEMT

HARDWARE OPTIONS

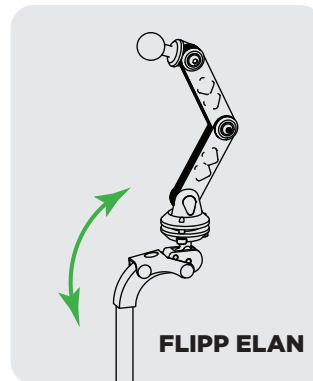

FLIPP ELAN

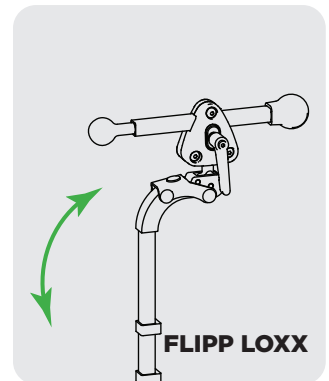

FLIPP LOXX

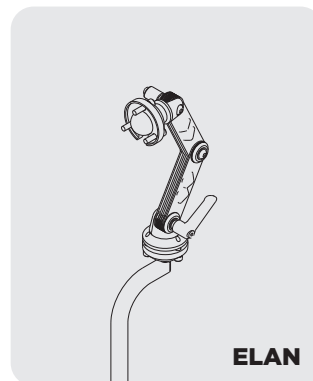

ELAN

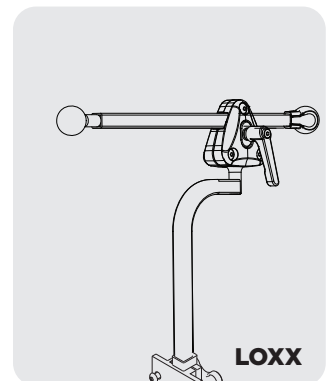

LOXX

Motion Concepts
www.motionconcepts.com
info@motionconcepts.com

USA
700 Ensminger Rd., Suite 112
Tonawanda, NY 14150
(888) 433-6818
Fax: (888) 433-6834

Canada
505 Cityview Blvd. Unit 1
Vaughan, ON L4H 0L8
(866) 748-7943
(905)-695-0134
Fax: 905-695-0138

© 2025 Matrix is a registered trademark of Motion Concepts. Specifications are subject to change without notification.

